

VCG

# CATÁLOGO

## ACESSÓRIOS DE ESQUADRIAS

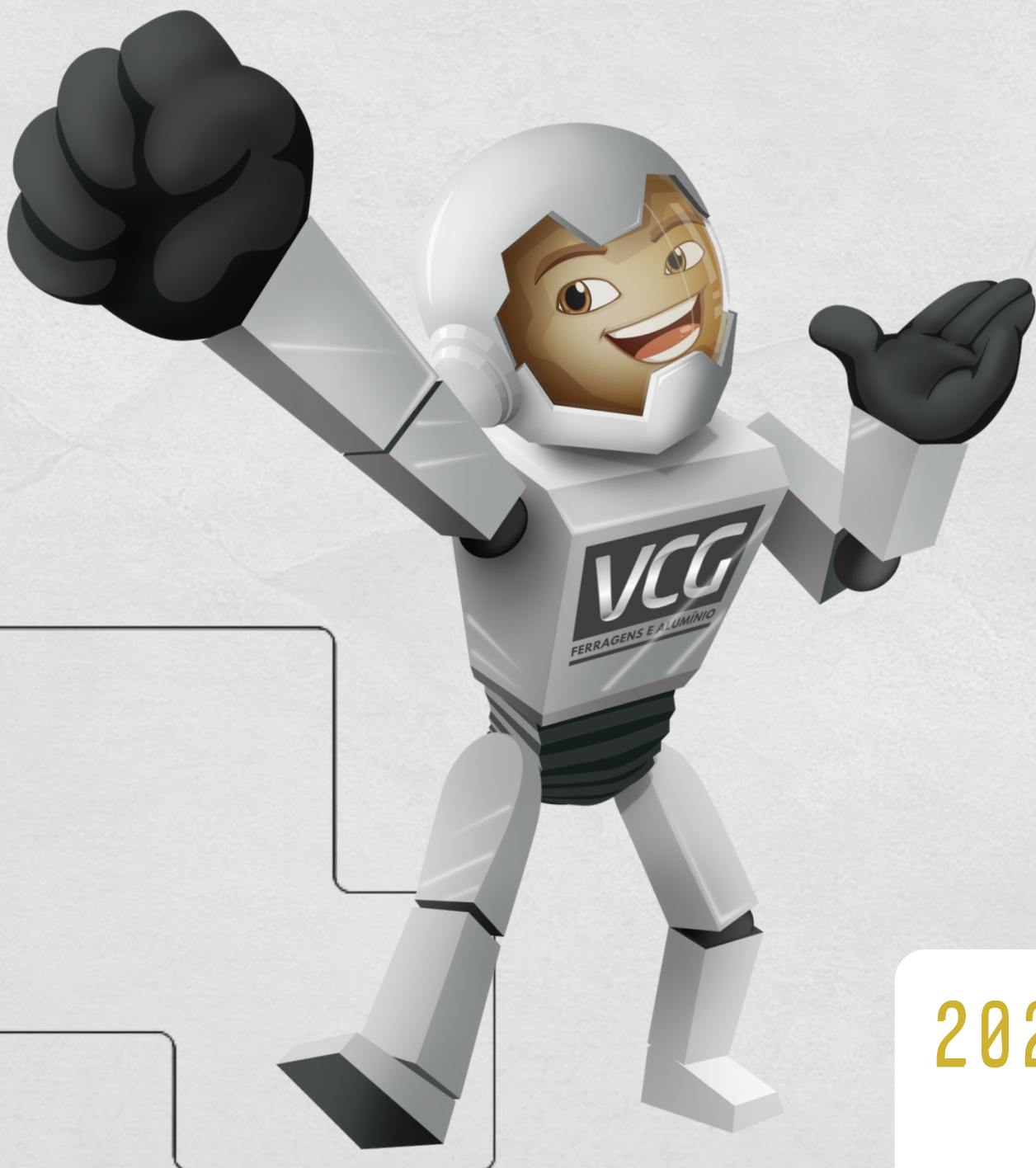

2024



# ÍNDICE

## POR LINHA

<b>LINHA GOLD</b>	03
1   TIPOLOGIA CORRER	04
2   TIPOLOGIA MAXIM-AR	09
3   TIPOLOGIA GIRO	10
4   KIT CREMONA	11
5   OUTROS	12



**VCG**

**LINHA GOLD**



# TIPOLOGIA CORRER

**UDINESE FECHO CONCHA  
7411/A SLIDE - GOLD**



**UDINESE FECHO CONCHA  
7811/A/C SLIDE GOLD**

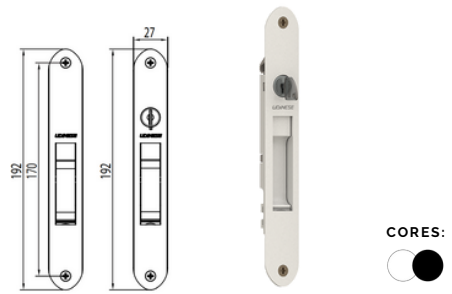

**UDINESE FECHO CONCHA  
8611/A/C TOUCH SQUARE**

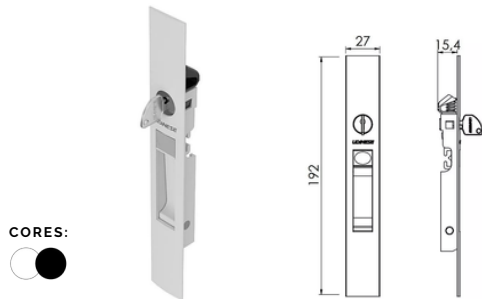

**UDINESE CONCHA CEGA  
7711/8511 SLIDE/TOUCH**

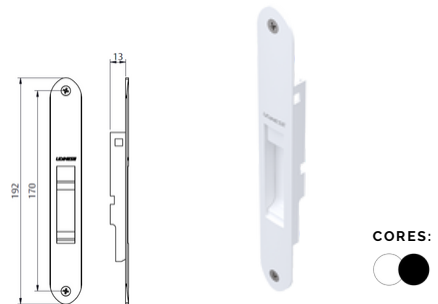

**UDINESE CONCHA CEGA  
7711/8511 SQUARE  
(QUADRADA)**





# TIPOLOGIA CORRER

**UDINESE PUXADOR  
PUX 008**



CORES:  
○ ●

**UDINESE PUXADOR  
ARCOS 250**

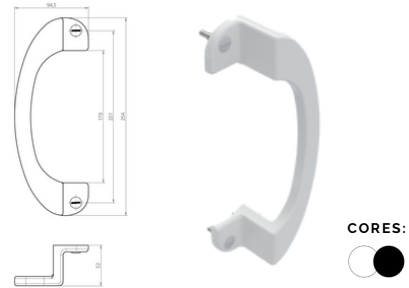

CORES:  
○ ●

**UDINESE PUXADOR  
LINEA 166MM**

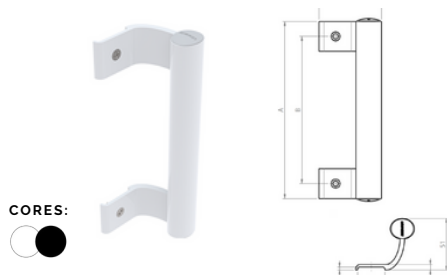

CORES:  
○ ●

**UDINESE PUXADOR  
LINEA 198MM**

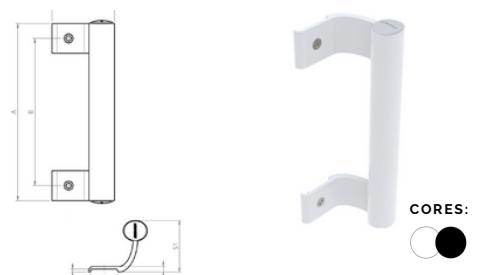

CORES:  
○ ●

**UDINESE PUXADOR  
LINEA 600**

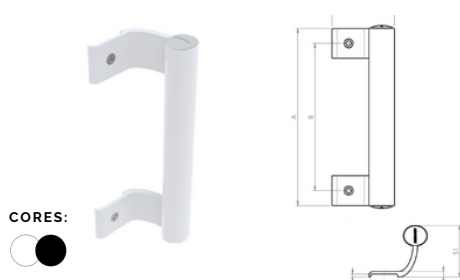

CORES:  
○ ●

**PUXADOR ESQUADRIA  
PEQUENA**



CORES:  
○ ●

**PUXADOR ESQUADRIA  
GRANDE**

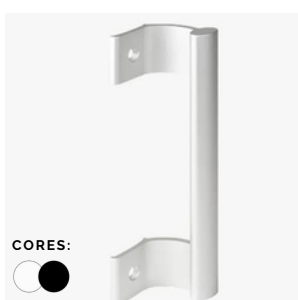

CORES:  
○ ●

# TIPOLOGIA CORRER

**ALUMICONTE PUX 650**



**UDINESE TRAVA FOLHA  
FIXA SP803 S/A SUP 622  
C/2PCS**



**UDINESE ROLDANA GOLD  
DUPLA SD2581/S3 ROL 413**



**UDINESE ROLDANA GOLD  
SIMPLES SD 2581/S3 (ROL 468)**



**UDINESE ROLDANA PEDRA  
DUPLA CONCAVA GOLD C/1 PC**



**UDINESE ROLDANA R28 CONCAVA  
ROL 301 C/2 PCS**



**UDINESE ROLDANA UDIPLUS  
DUPLA 200KG GDI**



**ALUSHOW GOLD ROLDANA INOX  
DUPLA 200 KGS TRILHO REDONDO**



## TIPOLOGIA CORRER

**ALUSHOW GOLD ROLDANA  
INOX DUPLA 200 KGS TRILHO U**





# TIPOLOGIA MAXIM-AR

**UDINESE BRACO UDMAX GOLD  
DESLIZANTE CX15 350**



**UDINESE BRACO UDMAX  
GOLD DESLIZANTE CX15 600**



**UDINESE BRACO UDMAX  
GOLD DESLIZANTE CX15 950**



**UDINESE FECHO FACHADA  
7969 DIR B32 CIT2/ATL**



**UDINESE FECHO FACHADA  
7969 ESQUERDA B32  
CIT2/ATL**



**UDINESE FECHO MAX-AR  
735D GOLD C/BAG C/CTF**



**UDINESE FECHO MAX-AR 735E  
GOLD (FEC496/FEC1124)**



# TIPOLOGIA GIRO

**UDINESE MAGIC DOOR  
OPERADOR PORTA DE  
GIRO 110V/220V**



**UDINESE VEDA PORTA  
INFERIOR AUTOMATICO  
820MM**



**UDINESE VEDA PORTA  
INFERIOR AUTOMATICO  
920MM**



**UDINESE VEDA PORTA  
INFERIOR AUTOMATICO  
1020MM**



**UDINESE VEDA PORTA  
INFERIOR AUTOMATICO  
1200MM**



**UDINESE VEDA PORTA  
INFERIOR AUTOMATICO  
1500MM**



# KIT CREMONA

**UDINESE KIT CREMONA E25  
ECO 400MM INT MAC/6635**

CORES:



**UDINESE KIT CREMONA E25  
ECO 600MM INT MAC/6635**

CORES:



**UDINESE KIT CREMONA E25 ECO  
800MM CHA/INTMAC/6635**

CORES:



# OUTROS

**UDINESE BARRA ANTIPANICO  
FECHADURA PRIME**



**UDINESE FECHADURA 340A  
400/60/R260(SQUARE)**



CORES:  
○ ●

**UDINESE FECHADURA  
357 200/70 C/ ROLETE**



CORES:  
● ●

**UDINESE FECHADURA 815 A  
400/45 ROUND (FRA820)**



CORES:  
○ ● ●

**UDINESE FECHADURA  
816 A TETRA**



CORES:  
○ ●

**UDINESE FECHADURA  
ELETRONICA SMART LOCK  
DIREITA**



CORES:  
○ ●

**UDINESE FECHADURA  
ELETRONICA UDINEXT-100**



CORES:  
●

**UDINESE FECHADURA GIRO  
321 400/45/ROUND**

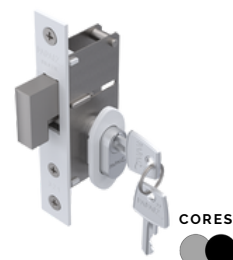

CORES:  
○ ●

# OUTROS

**UDINESE CONEXAO  
ALINHAMENTO CON 433**



**ALUMICONTE NYL - 190 -  
PRESILHA DO ARREMATE**

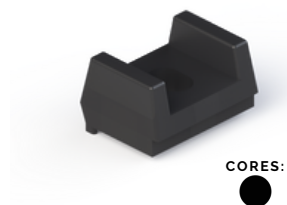

**UDINESE CALCO MONTANTE  
SP814 CAL 929**



**UDINESE DOB SOBREPOR  
UDISUPER**



**UDINESE PIVOT SEM  
REGULAGEM 300KG INOX**



**UDINESE DOB 798/DOB-  
828/50 2 ABAS**



**UDINESE GUIA DESLIZANTE  
SP812N**



**UDINESE TAPA FURO  
TPF95 PP**



# OUTROS

**UDINESE TAMPA MONTANTE  
GOLD NYL 399**

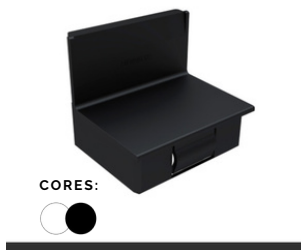

**UDINESE TAMPA MONTANTE  
GOLD NYL 400**



**UDINESE TAMPA MONTANTE  
GOLD NYL 401**



**UDINESE CAIXA DRENO  
NYL 395**

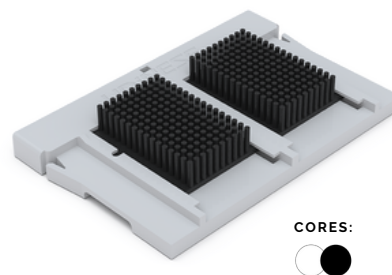

**UDINESE BATEDEIRA  
NYL 398**

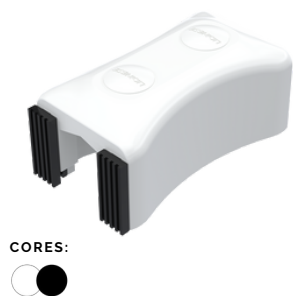

# OUTROS

**UDINESE MAGIC DOOR  
SENSOR DE PRESENÇA**



**UDINESE MAGIC DOOR  
BOTOEIRA TOUCHLESS INOX**



**UDINESE BARRA ANTIPANICO  
PRIME PUSH HORIZONTAL T1**



**UDINESE BARRA ANTIPANICO  
PRIME PUSH VERTICAL T2**



**PROLONGADOR GUARDA CORPO  
SEM REGULAGEM- GLASS VETRO**



**PROLONGADOR GUARDA  
CORPO COM REGULAGEM VCG**



# VCG

FERRAGENS E ALUMÍNIO



[WWW.VCGFERRAGENS.COM.BR](http://WWW.VCGFERRAGENS.COM.BR)

+55 71 3013-1515 / 3258-4848

AV. BARROS REIS, 618 - SALVADOR, BA